

# Mounting instructions

Bitumen roof

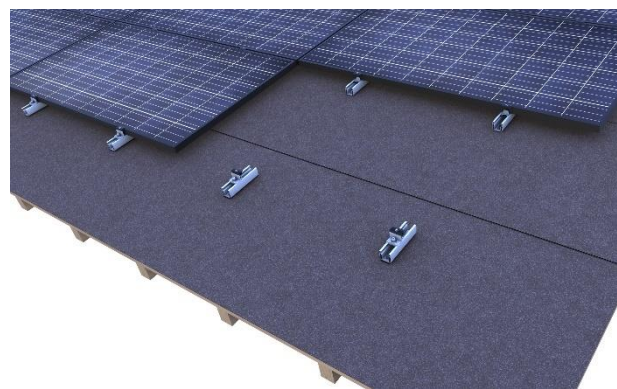
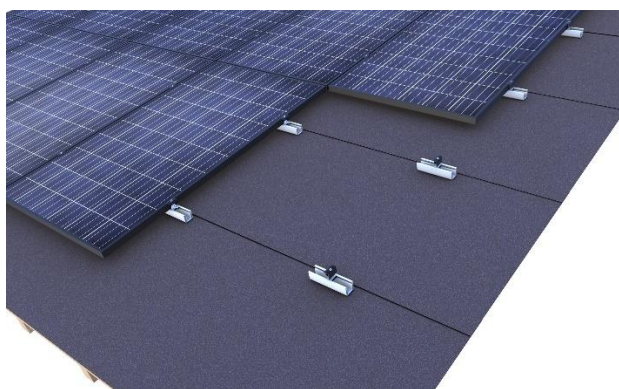
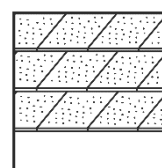

## TABLE OF CONTENTS

<b>1</b>	<b>Notes</b> .....	<b>1</b>
<b>2</b>	<b>Maintenance of the mounting system</b> .....	<b>4</b>
<b>3</b>	<b>novotegra for bitumen roof</b> .....	<b>4</b>
<b>4</b>	<b>System components, tools and equipment</b> .....	<b>5</b>
4.1	What is required for mounting .....	5
4.2	Mounting system components - optional.....	6
<b>5</b>	<b>Installing the mounting system</b> .....	<b>7</b>
5.1	Direct attachment: clamping system .....	7
5.2	Module mounting – clamping system.....	8
5.3	Clamping system mounting versions .....	9
<b>6</b>	<b>Warranty / product liability (exclusion)</b> .....	<b>10</b>

# 1 Notes

The following instructions are generally valid for our mounting system novotegra and are to be applied or interpreted accordingly regardless of the respective roof and mounting system type.

## Safety information

Mounting tasks may only be carried out by qualified and competent persons. During the work protective clothing in accordance with the relevant national regulations and guidelines must be worn.

Mounting must be carried out by at least two persons to ensure help in case of an accident.

All relevant national and locally applicable health and safety regulations, accident prevention regulations, standards, construction standards and environmental protection regulations as well as all regulations of the employers' liability insurance associations must be complied with.

The national regulations for working at height / on the roof must be complied with.

Electrical work must be carried out in compliance with the national and locally applicable standards and guidelines and the safety rules for electrical work.

Earthing / equipotential bonding of the mounting system must be carried out in accordance with the national and locally applicable standards and guidelines.

## Categorisation into hazard classes

To alert the user of potential danger situations the hazard classes analogous to ANSI Z 535 are used. The hazard class describes the risk if the safety information is not observed.

Warning symbol with signal word

Hazard class analogous to ANSI Z 535



**DANGER!** describes an immediate danger. If it is not avoided, death or serious injury will result.



**WARNING!** describes a potential danger. If it is not avoided, death or serious injury might result.



**CAUTION!** describes a potential danger. If it is not avoided, light or minor injury might result.



**NOTE!** describes a potentially harmful situation. If it is not avoided, the plant or objects in its vicinity might be damaged.

## General information

After receipt the goods must be inspected for completeness using the accompanying delivery note.

novotegra GmbH does not accept the costs, nor can we guarantee subsequent express deliveries if missing material is only noticed during mounting.

Since our mounting systems are subject to continuous development, mounting processes or components may change. Therefore, please check the current status of the mounting instructions on our website prior to mounting. We are also happy to send you current versions upon request.

The mounting system is suitable for the attachment of PV modules with standard market dimensions. Please find more detailed information about this in chapter 3.

The usability of the mounting system for the respective project must be checked for each individual case on the basis of the roof cover / roof construction / facade present.

The roof cover / roof construction / facade must meet the requirements of the mounting system with regard to load bearing capacity, support structure and condition.

Requirements for the material of the roof construction / roof cover / facade:

Wooden components (rafters/purlins/wooden formwork/ OSB – oriented strand board): min. strength class C24, no fungus infection or rot. OSB with material grade OSB 3

Tensile strength  $R_m$ , min for trapezoidal metal: steel 360 N/mm<sup>2</sup>; aluminium 195 N/mm<sup>2</sup>

Wall construction material: concrete, brick or sand-lime brick in solid or hollow block design.

The load bearing capacity of the roof / roof construction (rafters, purlins, trapezoidal metal, concrete floors, number of adhesive points, folded seams, etc.) or the facade (wall construction materials) must be checked by the user or a check be commissioned.

Physical building aspects concerning insulation penetrations (e.g. condensation) must be taken into account by the user.

### **Notes on mounting**

The components of the novotegra mounting system are intended exclusively for the attachment of PV modules. Dependent on the roof type of the building the designated mounting system components must be used.

A condition for the intended use of the novotegra mounting system is the mandatory compliance with the specifications in these instructions regarding safety information and mounting.

In case of unintended use and non-compliance with the safety information and mounting instructions and non-utilisation of the corresponding mounting components or use of third party components not belonging to the mounting system any warranty and liability claims against the manufacturer are voided. The user is liable for damage and resulting consequential damage to other components, such as PV modules, or the building as well as personal injury.

The user must read the mounting instructions prior to mounting. Unresolved issues must be clarified with the manufacturer prior to mounting. The mounting sequence in these instructions must be adhered to.

It must be ensured that a copy of the mounting instructions is accessible in the immediate vicinity of the work on site.

The mounting specifications (module load, attachment, clamping areas etc.) of the module manufacturer must be observed and complied with.

Prior to mounting the mounting system must be statically calculated with the loads to be assumed for the building project in accordance with the national standards. Information relevant to mounting (e.g. roof hook distance, lengths of bolts, overhang and protrusions or distance of base trough and required ballast) must be determined by the static calculation using the design software [www.solar-planit](http://www.solar-planit).

The permissible roof inclination for using the mounting system according to these installation instructions is 0 to 60 degrees for roof-parallel installation on a pitched roof and 0 to 5 degrees for elevated installation on a flat roof. Facade systems must be mounted parallel to the facade.

For roof-parallel installation with the clamping system, two module support rails per module must be mounted symmetrically under the modules for equal load transfer into the substructure. Alternatively, the roof-parallel installation can also be installed with insertion rails.

The specified tightening torques must be adhered to and checked randomly on site.

### **Notes on static calculations**

The mounting system must generally be statically calculated for each individual project using the design software Solar-Planit. Excluding façade systems, the calculation for this will be carried out by the company novotegra GmbH.

The static calculation only determines the load bearing capacity of the novotegra mounting system and also takes account of the attachment to the building (rafters, purlins, trapezoidal metal, wooden formwork, facade etc.). The load transfer within the building is not considered (customer static calculations).

The load bearing capacity of the mounting system components is determined on basis of the planned module layout and the underlying building information (project data recording). Deviations from the planning on site may lead to different results.

The load assumptions (load and roof division) are country-specific in accordance with the specifications of the Eurocode load standards. The determination of the loads to be assumed for Switzerland is in accordance with SIA 261.

At pitched roof, the modules may not be fitted above the gable end, ridge and eaves or the facade (increased wind load). At the ridge the modules may be fitted up to max. a theoretical horizontal line with the ridge tile and perfectly flush with the gable end. In the eaves area the modules may reach to max. the end of the roof cover due to loads.

In case of an exposed building position (with wind load e.g. at the edge of a slope) or snow accumulation (e.g. dormer or catchment grill or roof structures like domelights etc) the specifications of the Eurocode load standards or SIA 261 (Switzerland) must be taken into account by the user within his own responsibility. The design software does not consider these cases.

The static calculation of the mounting system is based on the symmetrical placement of the modules on the mounting rails at the longitudinal side of the modules (roof-parallel clamping systems) or on the support components (elevation) for equal load transfer into the substructure. For the insertion system a cross rail arrangement is expected for equal load transfer.

The results calculated with the design software, such as distances of the fasteners (e.g. roof hooks, stock screws, saddle clamps etc.), rail lengths and number of fasteners (e.g. direct attachment on the trapezoidal metal), overhang (e.g. rail and roof hook protrusions) or distances between the base troughs and number of fixing materials (e.g. rail joint) and the other calculation notes must be considered and complied with.

novotegra has been tested and certified by TÜV Rheinland:



## 2 Maintenance of the mounting system

The mounting system must be checked for stability and operation at regular intervals during the system maintenance.

In addition to the visual inspection of the components, we recommend a random check of the connections and the safe and correct position of the ballast on the base rails and ballast troughs.

Removal is possible in reverse order in the work steps mentioned below.

The maintenance work must be carried out by a specialist company with proven experience in electrical systems and work on mounting systems.

## 3 novotegra for bitumen roof

The contents of these assembly instructions describe the assembly of the mounting system on roofs with bitumen roofing and wooden formwork underneath. The maximum permissible module width is 1,34 m.

Depending on the mounting system construction, the loads from wind and snow are transferred to the roof covering as single or linear loads. The structural analysis of the mounting system only takes into account the fastening of the substructure to the roof covering. The static calculation of the roof covering due to the load from the PV construction must be prepared by the customer. The fastening to the roof covering is carried out with building authority approved 6.5 x 50mm E16 sealing screws.









Formwork C24: Minimum material thickness 21 mm → max. construction height 17 mm (with above-mentioned screw).

OSB3 formwork: minimum material thickness 18 mm → max. construction height 20 mm (with above-mentioned screw).





The required edge distances of the screw connection in the formwork must be observed. It must not be fastened in the joint of the formwork boards.

## 4 System components, tools and equipment





### 4.1 What is required for mounting

Clamping system			
Figure	Tool	Component*	Product group
		Short rail C24/C47 w. EPDM Material: Aluminium and EPDM (module in portrait/landscape)	Profile rails
		Mounting screw 6,5 x 50 E16 Tool: Socket AF 8 (module in portrait/landscape)	Roof attachment
		Middle clamps Material: Aluminium, aluminium cast and stainless steel Tool: Socket AF 8	Module attachment
		End clamps Material: Aluminium, aluminium cast and stainless steel Tool: Socket AF 8	Module attachment
		Module slip guard Material: stainless steel and aluminium (module in landscape/portrait)	Module protection and rail top cover

\* The components vary dependent on the roof requirements, the static calculation or the component selection and may differ from the figures above.

Figure	Equipment	Use for tools	Application
	Battery-operated screwdriver	Torx TX bit 40, 30 or 25 Socket AF 8	Clamp mounting component attachments
	Torque spanner up to min. 50 Nm	Special socket AF 18 deep, Socket AF 13	Protection
	Torque spanner up to min. 10 Nm	Socket AF 8	Clamp mounting
	Mitre saw	---	Rail section

## 4.2 Mounting system components - optional

Figure	Tool	Component***	Product group
		Top cover C-rail 2,000 mm Material: Aluminium	Module protection and rail top cover
		Cable-tie clip for profile flange	Cable fixing
		Cable clip d = 10 mm	Cable fixing
		Contact latch module clamp	Accessories and optional components

\*\*\* Optionally available mounting system components e.g. for the visual enhancement of the system, cable laying or the earthing of the mounting system.



## 5 Installing the mounting system

Prior to mounting, the module field on the roof must be measured and the position of the fasteners (e.g. roof hooks, hanger bolts, saddle clamps, short profiles etc.) defined taking into account the static calculation.

The individual mounting steps for mounting modules in landscape and portrait for the clamping system (chapter 5.1) are explained below. Reference is made to the mounting versions (MV) for clamping systems (chapter 5.3). This is followed by the corresponding work steps.

### 5.1 Direct attachment clamping system

#### Measuring short profiles

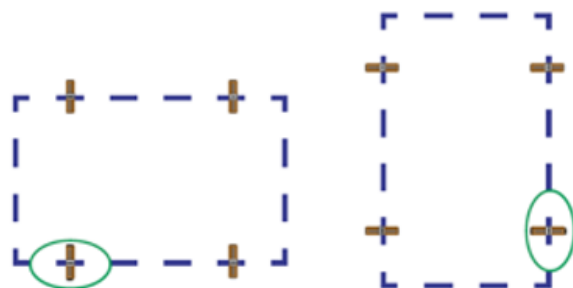

Mark the mounting position of the short profiles on the bitumen roofing depending on the module orientation – portrait or landscape - and the clamping areas specified by the module manufacturer. A gap of at least 10 mm must be maintained between the modules on the short frame side.

#### NOTICE

Module repeated spacing (framed) =  
module width B + 12 mm  
Module repeated spacing (frameless) =  
module width B + 15 mm

#### WARNING

To execute the work a scaffold must have been installed in accordance with the relevant specifications.

#### Attaching short profiles – portrait or landscape

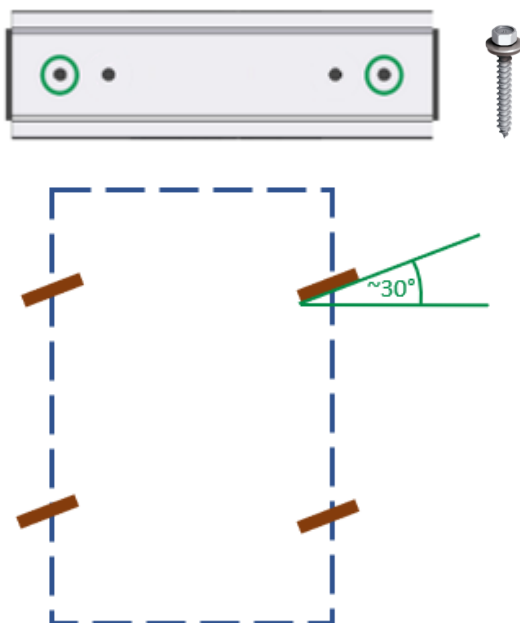

Each profile is fastened with at least 2 building authority approved sealing screws 6.5x50mm E16. The actual number of fasteners required is determined individually by the planning software. When screwing the profiles into the roof construction, make sure that no screw is fastened in the joint of the formwork boards. In addition, the edge distance of the screws of at least 19.5 mm (3x 6.5 mm) must be observed.

With bitumen shingles, screws may only be fastened on the shingle surface, but not in the shingle joint.

If the screw connection enters the formwork joint, the short profile can be turned by approx. 30° and fastened.

#### NOTICE

The sealing screws must be screwed at right angles to the raised beads, fixed on both edges of the slotted holes and may not be overtightened.

Depending on the roof structure, the screws may protrude from the underside of the formwork.

## 5.2 Module mounting – clamping system

### Module protection

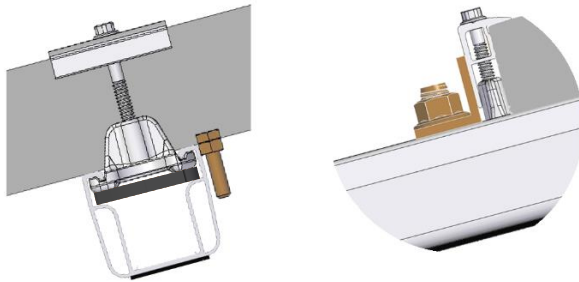

Prior to mounting modules in portrait, the module slip guards must be fitted to the frame holes above the bottom rail position (MV 3). For mounting modules in landscape module slip guard sets must be inserted at the lowest module row.

#### NOTICE

The module slip guard for mounting modules in landscape must be tightened with a tightening torque of 50 Nm.

### Module clamping

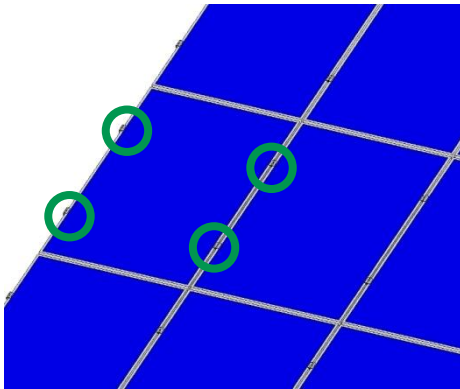

The modules must then be attached to the rails using end clamps and middle clamps – this applies analogously also to mounting the modules in landscape.

#### NOTICE

Minimum gap between modules along the short side 10 mm.

### Mounting the middle and end clamps

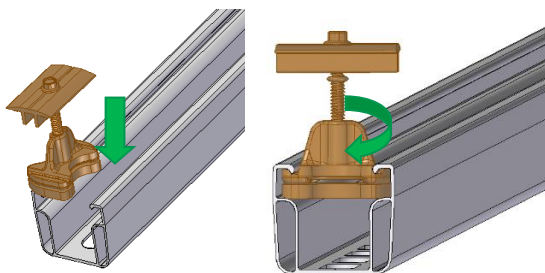

Insert the middle clamps or end clamps at the clamping position from above into the rail chamber. Then turn the rail nut in the rail and push the module clamps towards the module frame.

#### NOTICE

Tightening torque middle clamps 10 Nm  
Tightening torque end clamps 8 Nm  
Assembly of contact latch for module clamp please check MV 4

## 5.3 Clamping system mounting versions

Explanation of the mounting versions dependent on the design version (e.g. rail pieces, modules with box frame).

### MV 1 Short rails for module landscape or portrait



Short rail C47  
with EPDM 200 mm

Short rail C24  
with EPDM 125 mm

To improve ventilation behind the modules the modules can be mounted using the short rail C47, the mounting steps must be carried out as described in chapter 5.1.

### MV 2 Mounting the module slip guard for box frame

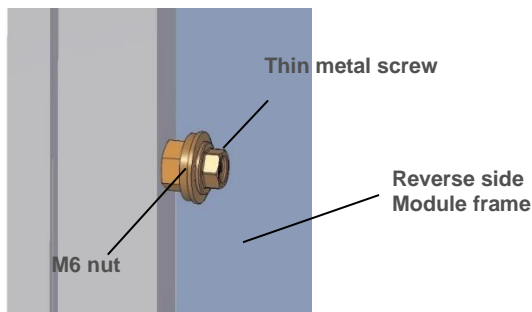

Push the nut over the screw and screw the thin metal screw into the module frame without predrilling.

#### NOTICE

The thin metal screw must not be overtightened.  
The approval of the module manufacturer might need to be obtained.

### MV 3 Space requirement for middle and end clamps

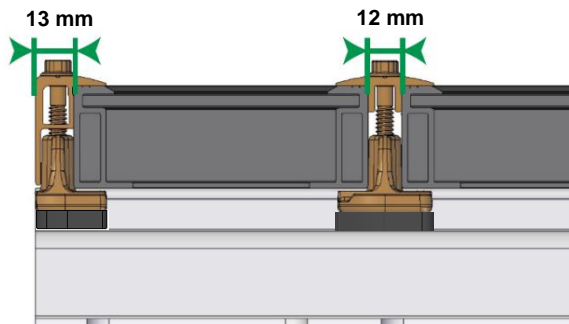

End clamp mounting flush with the rail end possible.

Push the modules all the way towards the rail nut of the middle clamps.

#### NOTICE

Middle clamp tightening torque 10 Nm  
End clamp tightening torque 8 Nm

### MV 4 Assembly of contact latch for grounding

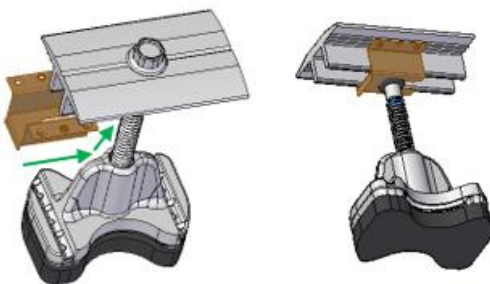

Push the contact latch on the sliding plate over the vertical webs of the middle clamp up to the screw.

#### NOTICE

Mounting of the middle clamp with the contact latch attached is carried out as described previously in chapter 5.2.

## 6 Warranty / product liability (exclusion)

In addition to the above-mentioned regulations and safety notices the applicable regulations and rules of technology must be observed by the installing specialist company.

The installer is responsible for the dimensioning of the mounting system.

The installer is responsible for the connection of the interfaces between the mounting system and the building. This also includes the tightness of the building envelope.

For flat roofs the roof insulation must be evaluated by the installer on site within his own responsibility regarding the material of the sealing layer, resistance, ageing, compatibility with other materials, overall condition of the roof insulation, need for a separating layer between the roof insulation and the mounting system. The required and necessary measures or precautions for the protection of the roof insulation for the mounting of the substructure of a PV system must be initiated by the installer with the aid of a specialist tradesman where necessary. novotegra GmbH does not accept liability for faulty or inadequate measures and precautions for the protection of the roof insulation!

The installer must review the friction coefficient used in the calculation for the verification of the slip safety of PV systems on flat roofs on site. Friction coefficients determined on site can be taken into account by entering them in the Solar-Planit planning tool. novotegra GmbH does not guarantee the correctness of the assumed values and is not liable for damage due to the use of incorrect values.

The specifications of the module, cable and inverter manufacturers must be observed. If these contradict the mounting instructions, always consult the novotegra GmbH sales team before mounting the novotegra mounting system or – in the case of components not supplied by novotegra GmbH – the manufacturer concerned.

During the preparation of the offers for novotegra by our sales staff the local conditions are not always sufficiently known, which is why changes to the offered quantities may result during installation. These changes relate mainly to the number of fasteners for the building envelope (for example roof hooks). In this case the additionally required components must always be installed in accordance with the dimensioning.

novotegra GmbH is not liable for incorrect or incomplete data collection sheets. Error-free and fully completed data collection sheets are essential for correct dimensioning.

The information in the mounting instructions, the warranty terms and the information about the liability exclusion must be noted.



# novotegra



## **novotegra GmbH**

Eisenbahnstraße 150  
72072 Tübingen | Deutschland

Tel. +49 7071 98987-0  
Fax +49 7071 98987-10

[info@novotegra.com](mailto:info@novotegra.com)  
[www.novotegra.com](http://www.novotegra.com)

